

④ **USB2.0 COMPLIANT**

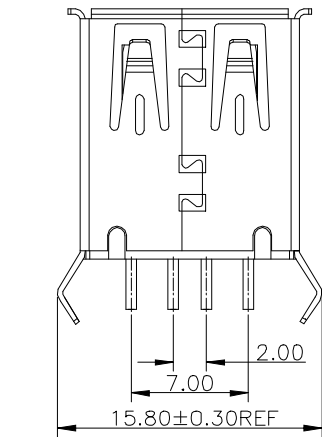

RoHS compliant

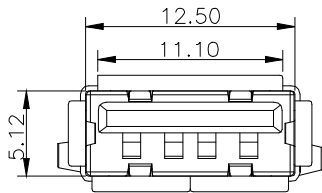
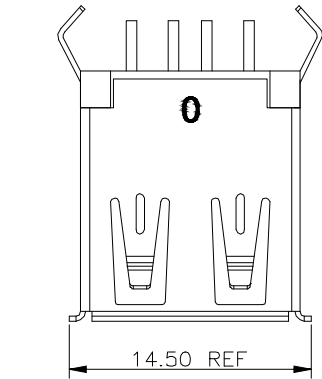
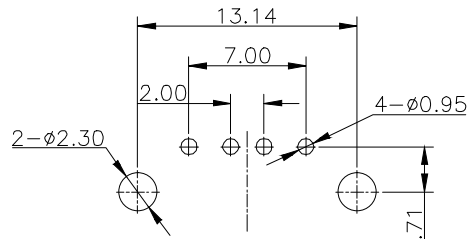

RECOMMENDED P.C.B LAYOUT
(TOLERANCE:±0.05)

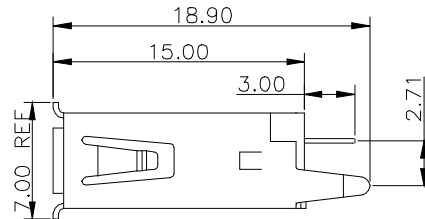

NOTES:

1.Material:

- 1.1 Housing: **PBT+30%GF UL94V-0, Color White**
- 1.2 Shell: **SPCC**
- 1.3 Contact :**Phosphor Bronze**

2. FINISH:

- 2.1 Contact Area: **Selective 5u"Au**
- Solder Area: Tin Plated**
- Under: Ni Plated**

3.MECHANICAL:

- 3.1 Mating Force:**3.57kgf Max.**
- 3.2 Unmating Force:**1.02kgf Min**
- 3.3 Durability:**1500 cycles Min**

4.ELECTRICAL:

- 4.1 Current Rating:**1.5A**
- 4.2 Dielectric Strength:**500V AC FOR 1 MINUTE**
- 4.3 Contact Resistance:**30mΩ Max**
- 4.4 Insulation Resistance:**1000 MΩ Min**

5.Operating temperature: -55°C TO +85°C

6.PACKIING: Tray

- ③Soldering temperature :
- 250°C for 5S in wave soldering
- 350°C for 5S in hand soldering

Scale	Free					Date	Name	Customer-No.
TOLERANCE		④	Update	24.07.2019	Xavier	Drawn	07.06.2013	Winnie
.X	±0.30	③	Update the soldering temperature	22.12.2017	Winnie	Approved	22.12.2017	Winnie
.XX	±0.20	②	Add the soldering temperature&page2	21.11.2016	Winnie			
.XXX	±0.10	①	Update the P/N	11.12.2013	Winnie			
DIM	TOL	①	Update the P/N	11.12.2013	Winnie			
X.°	±5°	①	Update the P/N	11.12.2013	Winnie			
Angle	TOL	①	Drawn	07.06.2013	Winnie			
UNIT	mm	Id.	Modification	Date	Name			Drawing-No.
								ASS 5767 CO
								Replace
								SHEET



ASS 5767 CO rev04 SHEET

1

2

3

4

5

6

7

A

Waving Soldering Graph

A

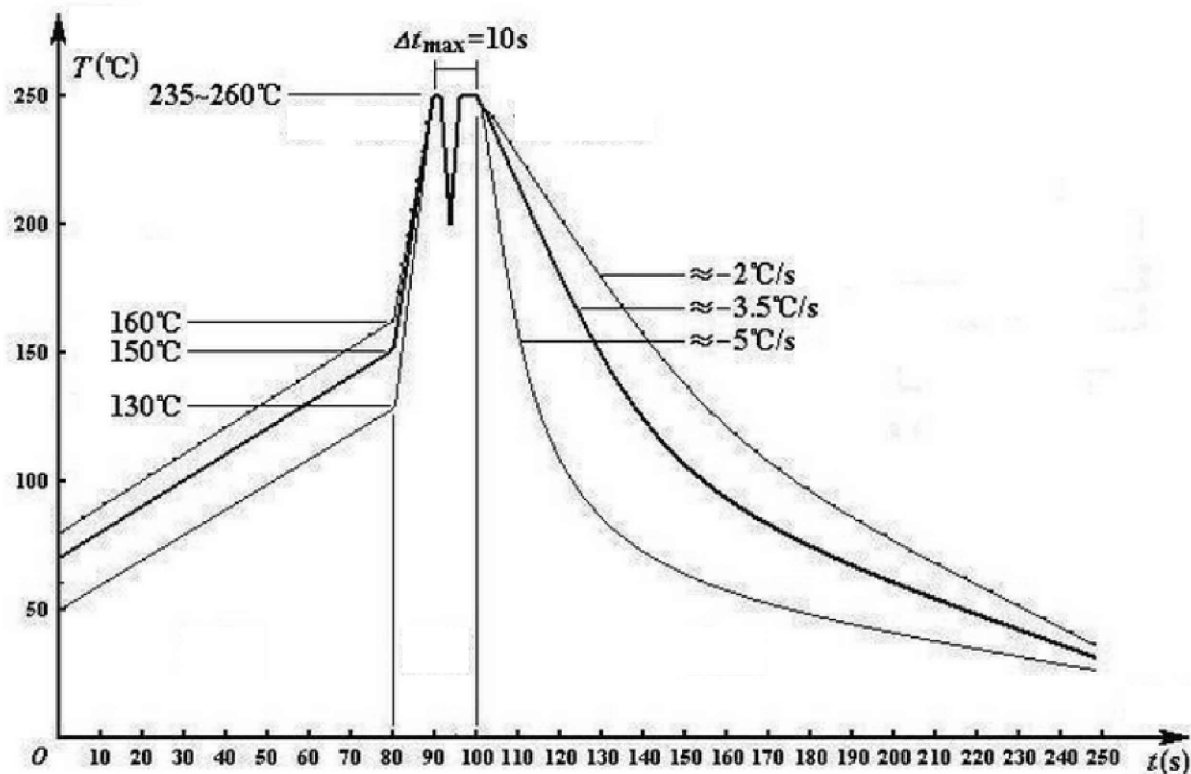

B

B

C

C

D

D

E

E

F

F

G

G

RoHS compliant

Scale	Free					Date	Name	Customer-No.
TOLERANCE		④	Update	24.07.2019	Xavier	Drawn	07.06.2013	Winnie
.X	±0.30	③	Update the soldering temperature	22.12.2017	Winnie	Approved	22.12.2017	Winnie
.XX	±0.20	②	Add the soldering temperature&page2	21.11.2016	Winnie			
.XXX	±0.10	①	Update the P/N	11.12.2013	Winnie			
DIM	TOL	①	Update the P/N	11.12.2013	Winnie			
X.°	±5°	①	Update the P/N	11.12.2013	Winnie			
Angle	TOL	①	Drawn	07.06.2013	Winnie			
UNIT	mm	Id.	Modification	Date	Name			
								ASSMANN WSW-No. ①AUSB2-AFN-MTP1
								Drawing-No. ASS 5767 CO
								rev04
								Replace SHEET

H

H

1

2

3

4

5

6

7