

1

2

3

4

5

6

7

A

A

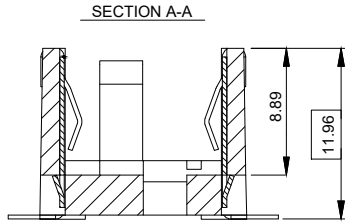
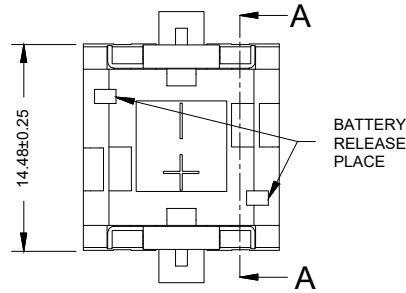
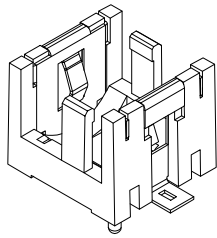

NOTE:

- 1.MATERIAL
 - 1.1 Contact: 0.30mm Thickness Phosphor Bronze
 - 1.2 Housing: Heat Resistance Nylon,UL94V-0
- 2.FINISH
 - 2.1 Contact: Gold Flash plated
- 3.Packing: Tape & Reel

B

B

C

C

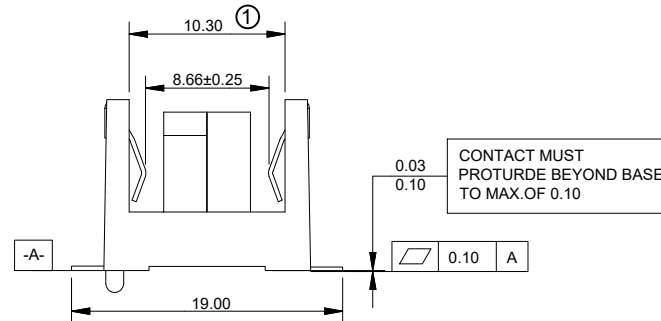
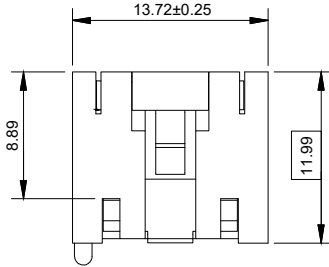
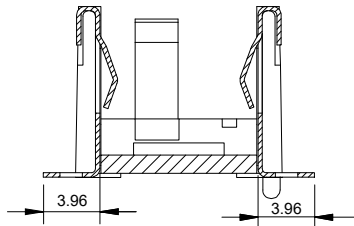

D

D

E

E

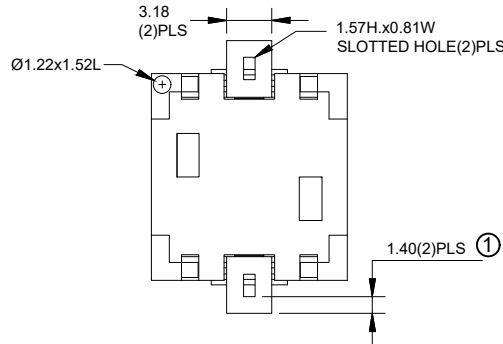

F

F

G

G

RoHS compliant
unit:mm

Scale	Free
TOLERANCE	
X.	±0.35
.X	±0.25
.XX	±0.20
.XXX	±0.15
DIM	TOL
Angle	TOL

			Date	Name	Description: Coin Cell Holder CR1/3N Type
		Drawn	01.12.2021	Peter	
		Approved	18.07.2022	Daniel	ASSMANN WSW-NO.
					A-BAT-CH-C0-EG-GSR1
①	Update dimension	18.07.2022	Daniel		Drawing-No.
②	Drawn	01.12.2021	Peter		ASS 9113 CO
Id.	modification	Date	Name		Customer-No.
					rev01
					SHEET 1 / 1

H

H

1

2

3

4

5

6

7