

1

2

3

4

5

6

7

A

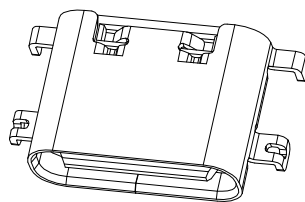
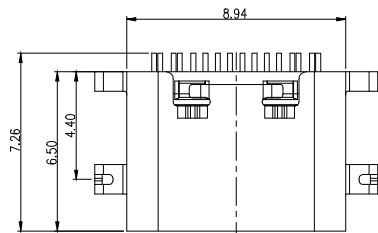

NOTES:

SPECIFICATION:

1. CURRENT RATING: 5.0A MAX
2. VOLTAGE: 100 VAC
3. TEMPERATURE RANGE: -30 °C ~ 85 °C
4. CONTACT RESISTANCE: 40 MILLIONHM MAX
5. INSULATION RESISTANCE: 100 MEGOHMS MIN.
6. LNSERTION FORCE : 5N~20N
7. UNMATING FORCE: 8N~20N
8. DURABILITY: 10,000 CYCLES

B

C

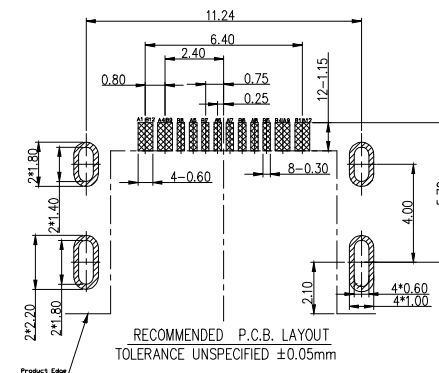
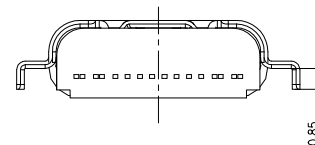
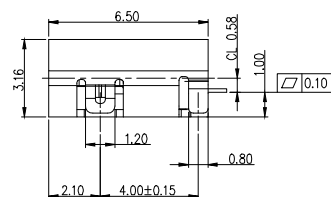
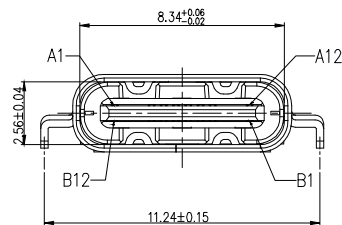

D

E

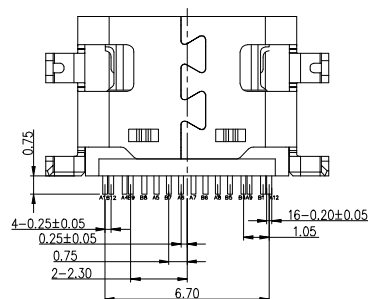

A1	GND	B12	GND
A4	VBUS	B9	VBUS
A5	CC1	B8	SBU2
A6	DP1	B7	DN2
A7	DN1	B6	DP2
A8	SBU1	B5	CC2
A9	VBUS	B4	VBUS
A12	GND	B1	GND
PIN	SIGNAL NAME	PIN	SIGNAL NAME

5	SHELL	STAINLESS STEEL	NI Plated	1PCS
4	SHIELDING PLATE	STAINLESS STEEL	---	1PCS
3	CONTACT	COPPER ALLOY	G/F/Ni Plated	1SET
2	CONTACT	COPPER ALLOY	G/F/Ni Plated	1SET
1	HOUSING	HIGH TEMPERATURE PLASTIC	BLACK	1PCS
NO.	DESCRIPTION	MATERIAL	REMARKS	QTY

F

G

**RoHS compliant**  
Unit: mm

Scale	Free
TOLERANCE	
X.X	±0.30
X.XX	±0.20
X.XXX	±0.10
DIM	TOL
X°	±2°

①	Update packing quantity	03.05.2023	Luca
②	Drawn	08.06.2022	Luca
Id.	Modification	Date	Name



Description: USB Connector	
USB2.0 TYPE C / FEMALE / 16pin / Offset Type	
ASSMANN WSW-No. <b>A-USBC-20F0-EA-GSR12</b>	
Drawing-No.	
<b>ASS 9311 CO</b>	rev01
Customer-No.	Sheet 1/2

H

1

2

3

4

5

6

7

A

B

C

D

E

F

G

H

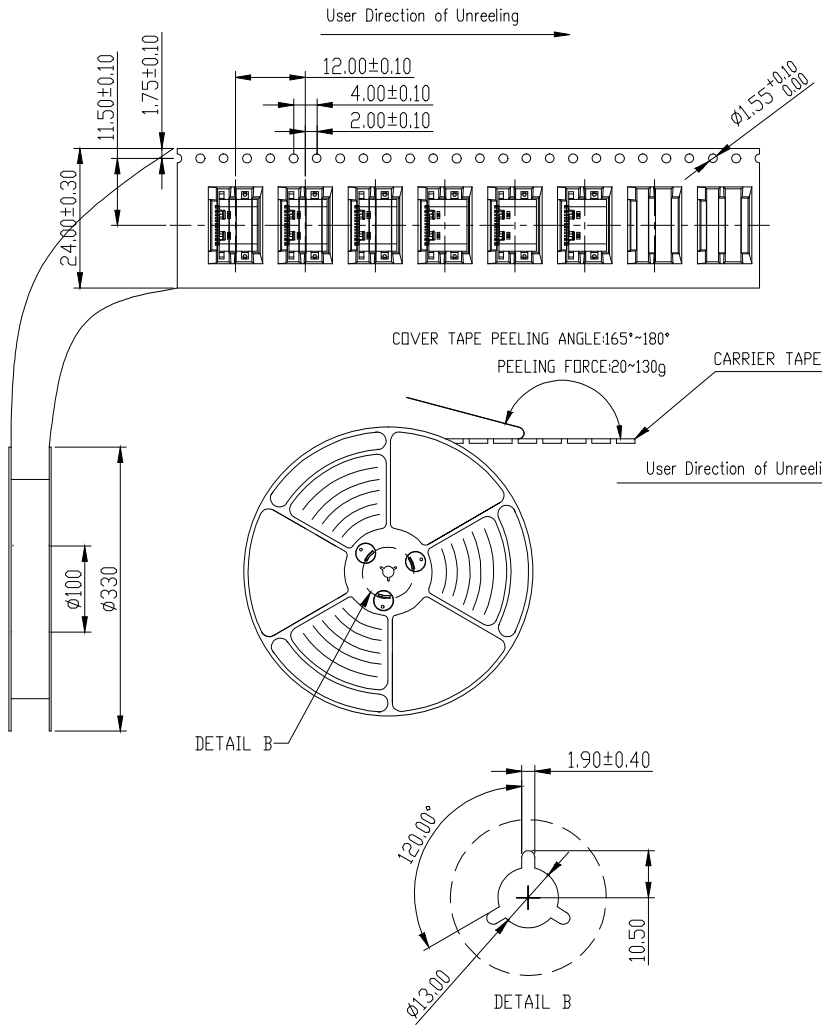

NOTES

1. NUMBER OF CONNECTORS:1400PCS/REEL ①
2. LEAD TAPE LENGTH ①
3. QUANTITY: 14000PCS/CARTON ①

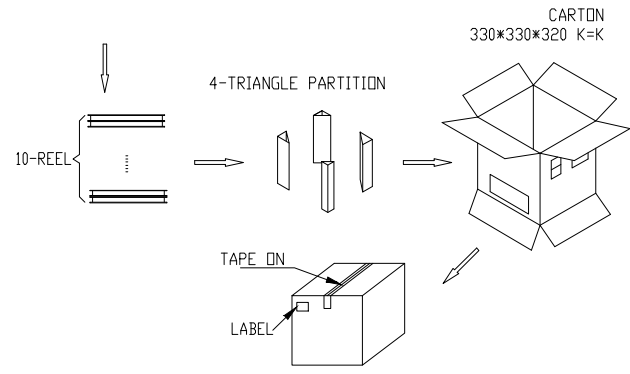

**RoHS compliant**  
Unit: mm

Scale	Free						Date	Name	Description: USB Connector USB2.0 TYPE C / FEMALE / 16pin / Offset Type
TOLERANCE						Drawn	08.06.2022	Luca	
X.X	±0.30					Approved	03.05.2023	Luca	ASSMANN WSW-No. A-USBC-20F0-EA-GSR12
X.XX	±0.20								Drawing-No.
X.XXX	±0.10								ASS 9311 CO
DIM	TOL	①	Update packing quantity	03.05.2023	Luca				rev01
X°	±2°	②	Drawn	08.06.2022	Luca			Customer-No.	Sheet 2/2
		Id.	Modification	Date	Name				