



Auf dem Schüffel 1  
D-58513 Lüdenscheid  
Tel.: +49-2351 - 5542-00  
Fax +49 (2351) 554-861  
info@assmann-wsw.com  
www.assmann-wsw.com

## PRODUCT CHANGE NOTIFICATION (PCN)

ISSUE DATE: 12.09.2023  
MODIFICATION / REVISION DATE: 12.09.2023

A-MJP-8-EG-LIB-S3  
RJ-Plug Crimp straight (180°) | RJ45 (8p/8c) Au 50µ" Cat 7

CHANGE NOTIFICATION: [PCN\\_20230912\\_AMJP8EGLIBS3](#)

DESCRIPTION OF CHANGES: [CHANGE OF DATA SHEET](#)  
[New Draw.-ASS\\_8962\\_COrev02](#)

REASON FOR CHANGE: [CHANGE OF PRODUCT DIMENSIONS, TOLERANCES AND/OR PROPERTIES](#)

KEY CHARACTERISTICS OF CHANGE: [Details see page 3](#)

PRODUCTS AFFECTED: [A-MJP-8-EG-LIB-S3](#)

DATE OF CHANGE AND IMPLEMENTATION: [CHANGE: 37/2023](#)  
[IMPLEMENTATION: 12.09.2023](#)

RESPONSE: [NO RESPONSE TO THIS NOTIFICATION IS REQUIRED](#)

### PCN REVISION HISTORY:

DATE OF REVISION: 12.09.2023

REVISION NUMBER: 00

page 1/

Auf dem Schüffel 1  
D-58513 Lüdenscheid  
Tel.: +49-2351 - 554-200  
Fax +49 (2351) 554-861  
info@assmann-wsw.com  
www.assmann-wsw.com

**PRODUCT CHANGE NOTIFICATION (PCN)**

ISSUE DATE: 12.09.2023  
MODIFICATION / REVISION DATE: 12.09.2023

REFERENCE DOCUMENTS / ATTACHMENTS:  
DOCUMENT: DRAWING

ASSMANN WSW P/N	Drawing Number		ASSMANN WSW P/N	Drawing Number
A-MJP-8-EG-LIB-S3	ASS_8962_COrev01	↔	A-MJP-8-EG-LIB-S3	ASS_8962_COrev02

Auf dem Schöffel 1  
D-58513 Lüdenscheid  
Tel.: +49-2351 - 554-200  
Fax +49 (2351) 554-861  
info@assmann-wsw.com  
www.assmann-wsw.com

## PRODUCT CHANGE NOTIFICATION (PCN)

ISSUE DATE: 12.09.2023  
MODIFICATION / REVISION DATE: 12.09.2023

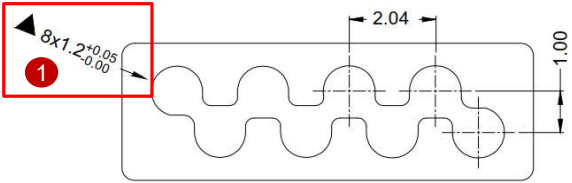
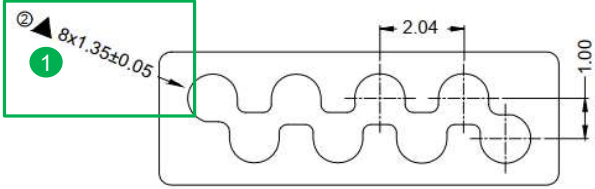
A-MJP-8-EG-LIB-S3	OLD VERSION	A-MJP-8-EG-LIB-S3	NEW VERSION
<p>1) Dimension 1.2+0.05/-0 mm</p> 	<p>1) Dimension 1.35+0.05/-0.05mm</p> 	<p>FOR DETAIL, PLEASE TAKE ATTACHED NEW DRAWING: ASS_8962_COrev02 FOR REFERENCE</p>	

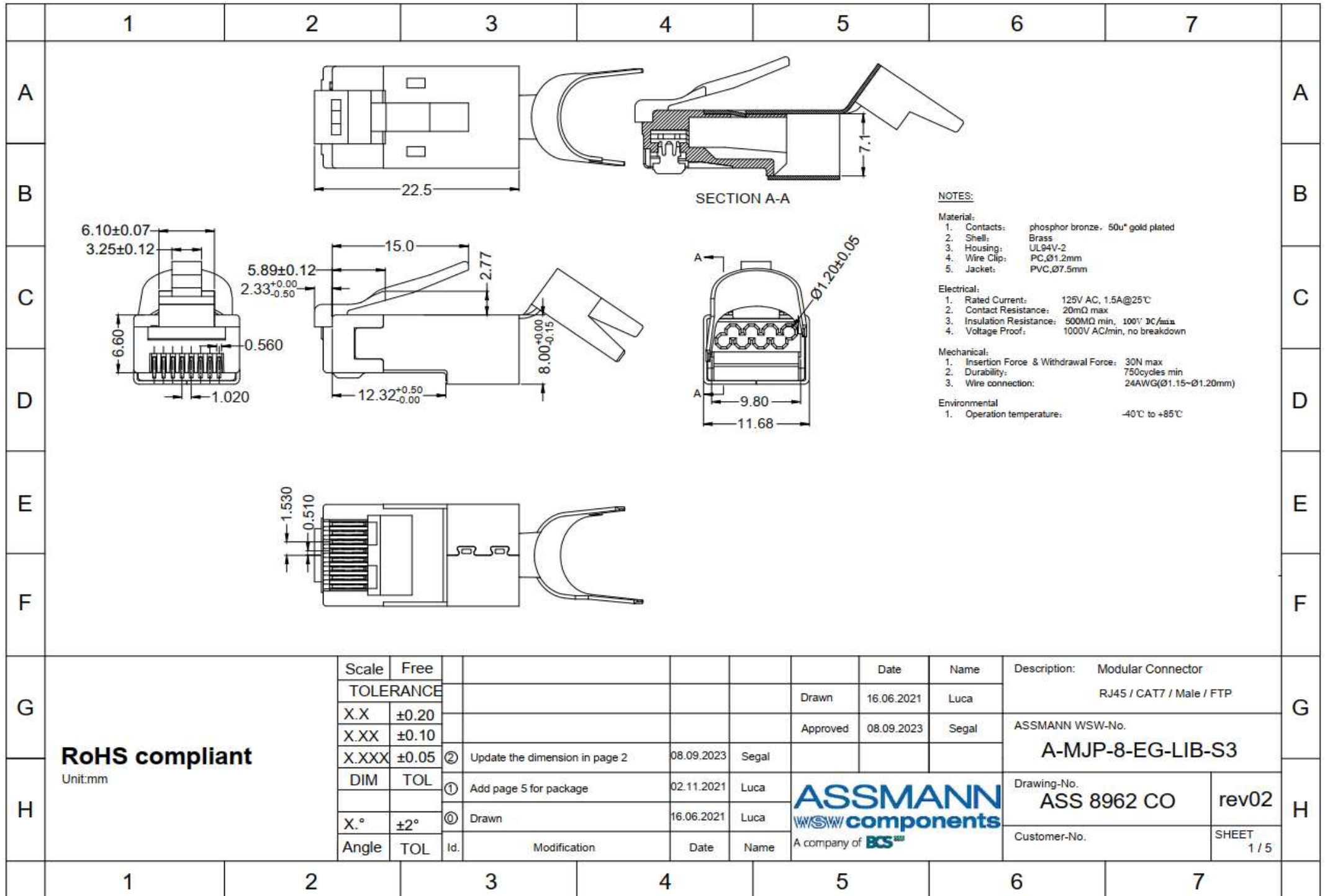

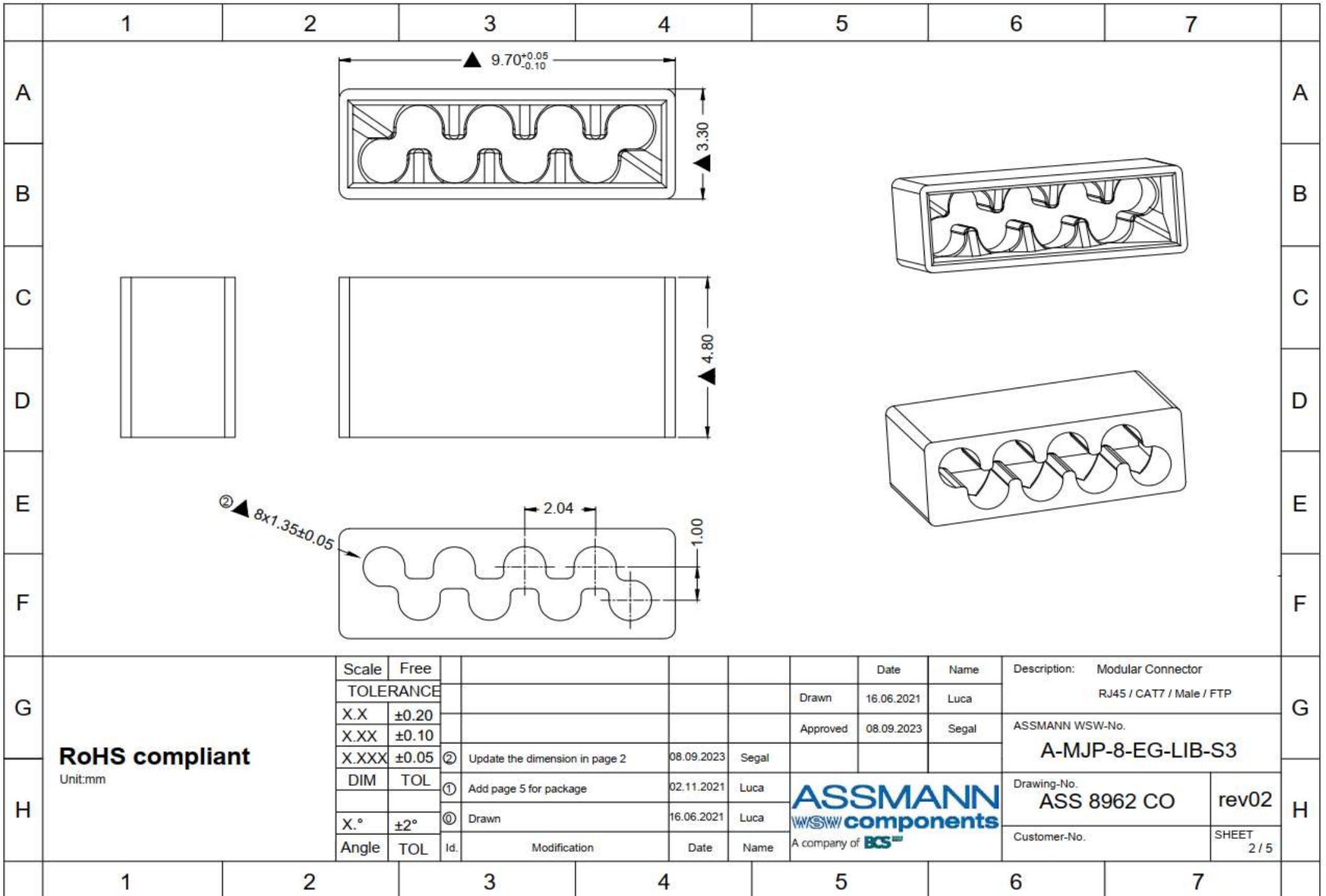







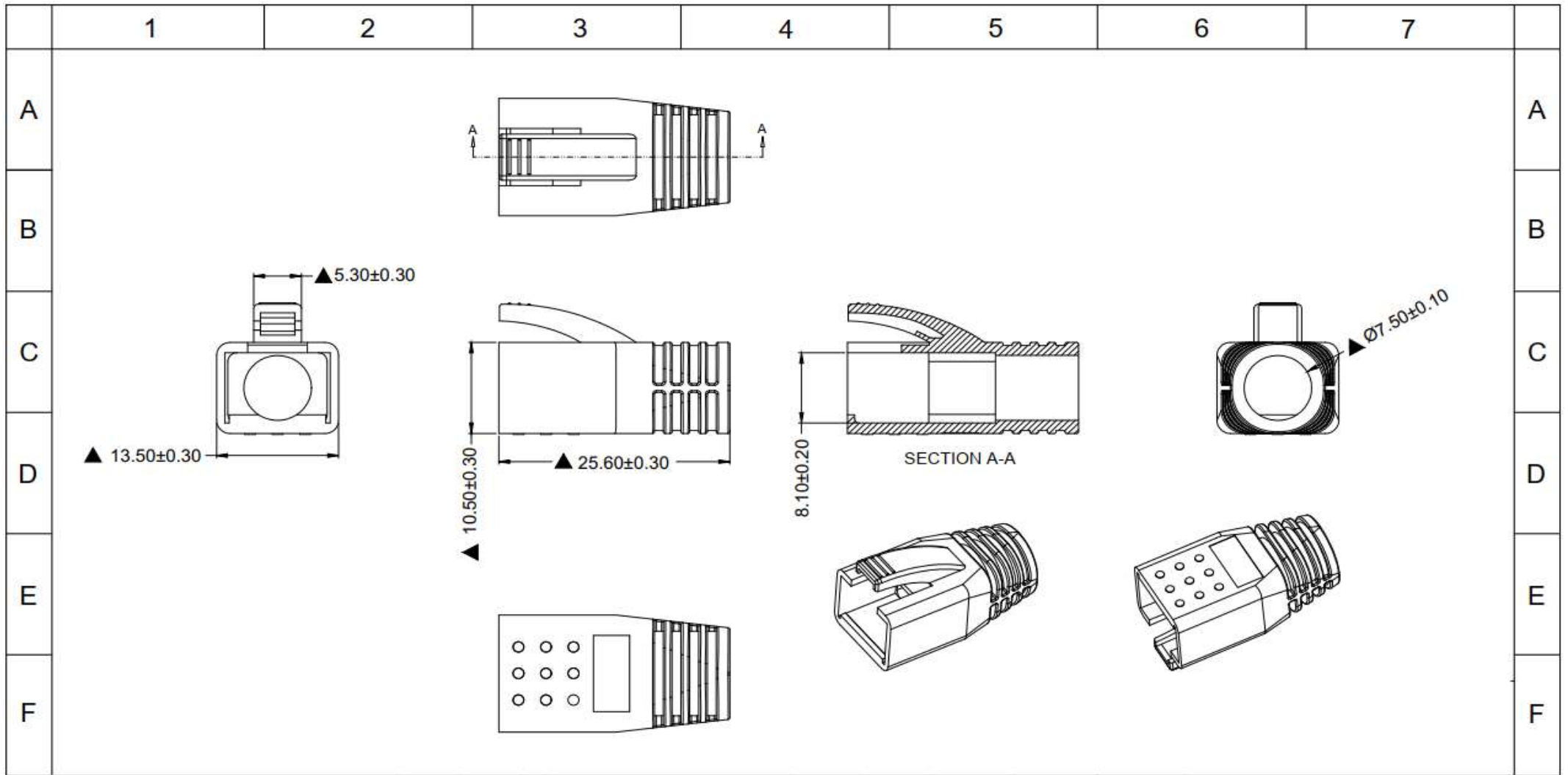





**RoHS compliant**  
Unit:mm



Scale	Free					Date	Name	Description:
TOLERANCE						Drawn	16.06.2021	Luca
X.X	±0.20					Approved	08.09.2023	Segal
X.XX	±0.10							
X.XXX	±0.05	②	Update the dimension in page 2	08.09.2023	Segal			
DIM	TOL	①	Add page 5 for package	02.11.2021	Luca	<b>ASSMANN</b> <b>WSW components</b> A company of <b>BCS</b>		
X.°	±2°	③	Drawn	16.06.2021	Luca			
Angle	TOL	Id.	Modification	Date	Name			

Description: Modular Connector	
RJ45 / CAT7 / Male / FTP	
ASSMANN WSW-No.	
<b>A-MJP-8-EG-LIB-S3</b>	
Drawing-No.	rev02
ASS 8962 CO	
Customer-No.	SHEET 2 / 5



G	RoHS compliant	Scale	Free					Date	Name	Description:	Modular Connector	
		TOLERANCE						Drawn	16.06.2021	Luca	RJ45 / CAT7 / Male / FTP	
H	Unit:mm	X.X	±0.20					Approved	08.09.2023	Segal	ASSMANN WSW-No.	
		X.XX	±0.10								A-MJP-8-EG-LIB-S3	
		X.XXX	±0.05	②	Update the dimension in page 2	08.09.2023	Segal					
		DIM	TOL	①	Add page 5 for package	02.11.2021	Luca			Drawing-No.	ASS 8962 CO	rev02
		X.°	±2°	③	Drawn	16.06.2021	Luca			Customer-No.		SHEET
Angle	TOL	Id.	Modification		Date	Name	A company of					

	1	2	3	4	5	6	7		
A	Instruction Manual:								A
B									B
C	1.Insert boot into cable.	2.Strip cable jacket 20mm, do not damage the braid.	3.Twust braid into strip.	4.Remove foil paper	5.Separate 4 pairs, cut the cross frame.	6.Arrange wires according to wire map.			C
D									D
E	7.Input wires into inner insert, cut the extra wires to flat.	8.Put inner insert to the end of plug.	9.Put plug into crimping tool and press.	10.Put the tail part into crimping tool and press.	11.After crimping	12.Push the boot upward to connect with the plug.			E
F									F

G	RoHS compliant	Scale	Free					Date	Name	Description: Modular Connector	G	
		TOLERANCE						Drawn	16.06.2021	Luca		RJ45 / CAT7 / Male / FTP
H	Unit:mm	X.X	±0.20					Approved	08.09.2023	Segal	ASSMANN WSW-No. <b>A-MJP-8-EG-LIB-S3</b>	
		X.XX	±0.10									
		X.XXX	±0.05	②	Update the dimension in page 2	08.09.2023	Segal					
		DIM	TOL	①	Add page 5 for package	02.11.2021	Luca			Drawing-No.	ASS 8962 CO	rev02
		X.°	±2°	③	Drawn	16.06.2021	Luca			Customer-No.		SHEET 4 / 5
Angle	TOL	Id.	Modification	Date	Name	A company of 						

**Packing:**

1. Take 100pcs below clips into a chain bag.

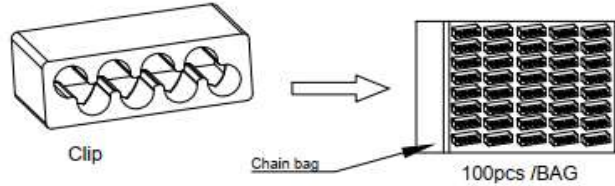

2. Take 100pcs below RJ45 plug into a Tray and stick a label on a corner.

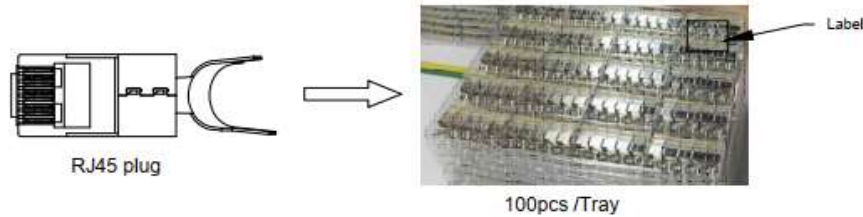

3. Take a bag of clips put on a tray with 100pcs RJ45 plugs.

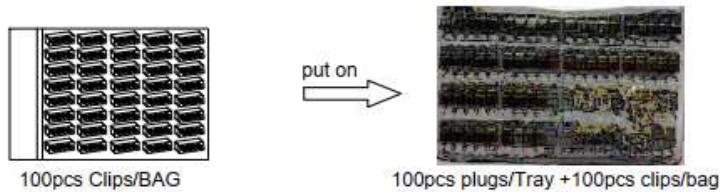

4. Take 35 trays into a carton and stick carton label on the top right corner.

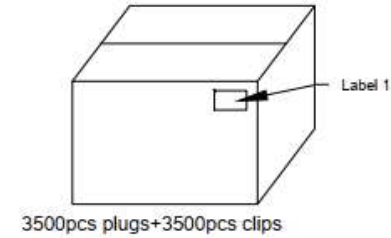

5. Packing the sheath. Put the "+" partition into a carton, then put 4000pcs sheathes into the carton. And stick carton label on the top right corner.

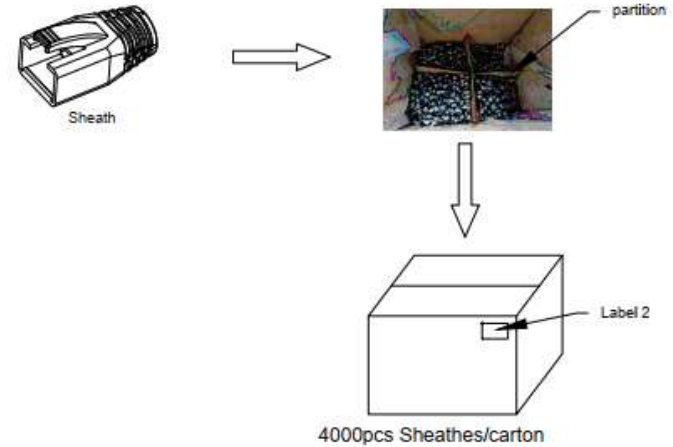

**RoHS compliant**

Unit:mm

Scale	Free					Date	Name	Description:
TOLERANCE						Drawn	16.06.2021	Luca
X.X	±0.20					Approved	08.09.2023	Segal
X.XX	±0.10							
X.XXX	±0.05	②	Update the dimension in page 2	08.09.2023	Segal			
DIM	TOL	①	Add page 5 for package	02.11.2021	Luca			
X.°	±2°	③	Drawn	16.06.2021	Luca			
Angle	TOL	Id.	Modification	Date	Name	Customer-No.		SHEET 5 / 5

G	Scale	Free					Date	Name	Description: Modular Connector
	TOLERANCE						Drawn	16.06.2021	Luca
	X.X	±0.20				Approved	08.09.2023	Segal	RJ45 / CAT7 / Male / FTP
	X.XX	±0.10							ASSMANN WSW-No.
H	X.XXX	±0.05	②	Update the dimension in page 2	08.09.2023	Segal			<b>A-MJP-8-EG-LIB-S3</b>
	DIM	TOL	①	Add page 5 for package	02.11.2021	Luca	Drawing-No.		ASS 8962 CO
	X.°	±2°	③	Drawn	16.06.2021	Luca	Customer-No.		rev02
	Angle	TOL	Id.	Modification	Date	Name			